

SELECTION MANUAL FOR
高速车载以太网HSED系列产品

HIGH-SPEED VEHICLE ETHERNET HSED SERIES

证券代码：300351

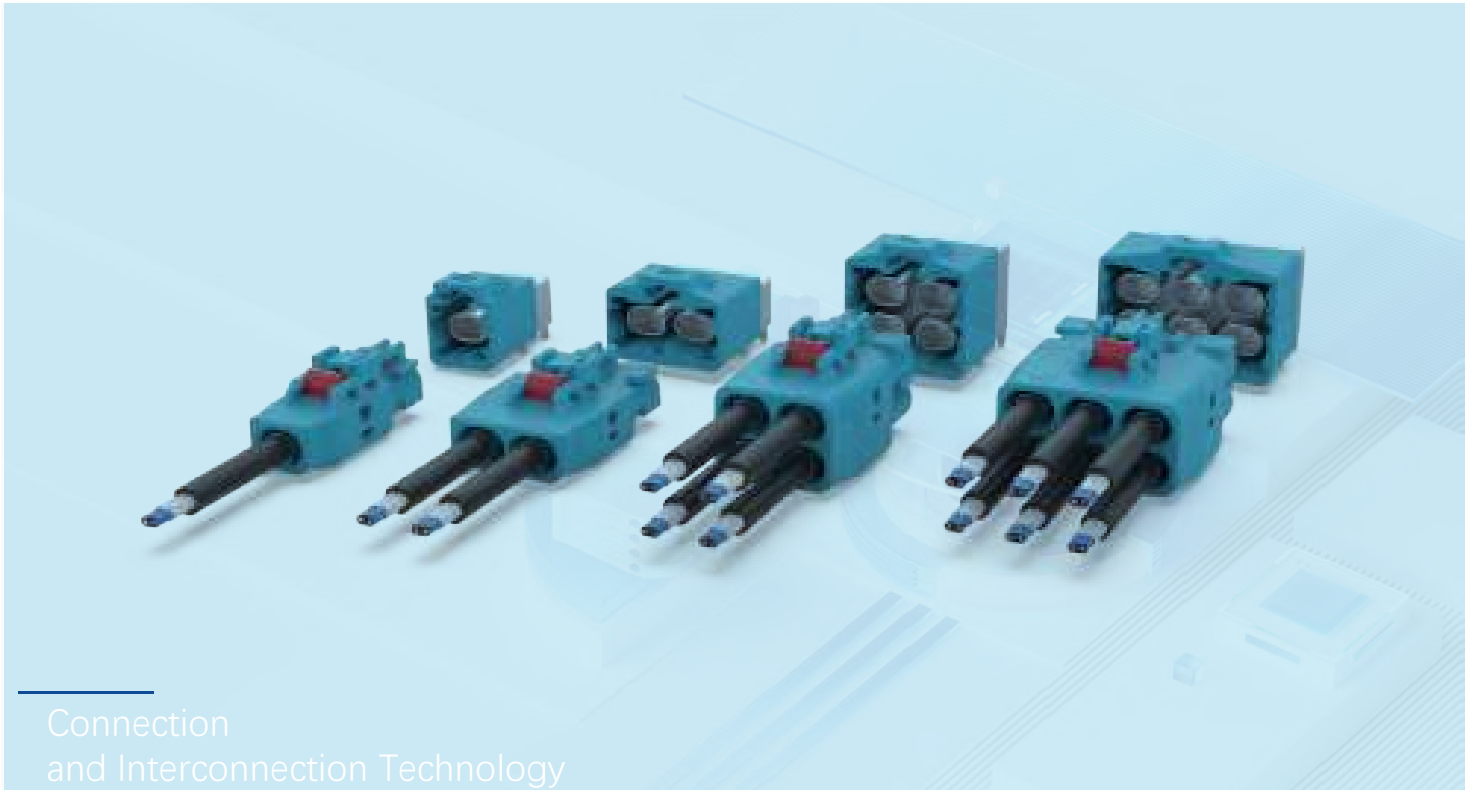

Connection
and Interconnection Technology
Solution

连接与互联技术解决方案

四川永贵科技有限公司

SICHUAN YONGGUI SCIENCE AND TECHNOLOGY CO., LTD

以客户为中心 实现价值最大化

Focus on customers to maximize value

CORPORATE VISIONV

世界级互连方案提供商
World class interconnect supplier

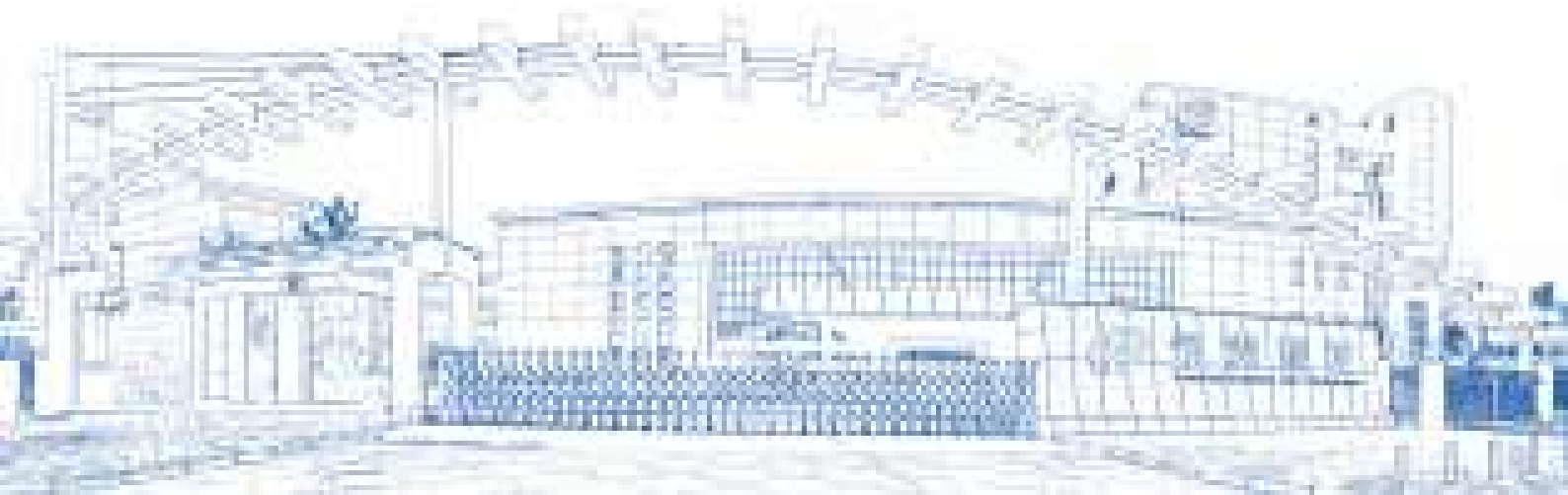

COMPANY PROFILE

企业介绍

浙江永贵电器股份有限公司是一家专注于各类电连接器、连接器组件及精密智能产品的研发、制造、销售和技术支持的国家高新技术企业，于2012年在深圳证券交易所上市（证券代码：300351）。公司轨道交通连接器产销量占国内轨交连接器市场份额第一，配套供应于中国中车集团、十八个铁路局以及建有轨道交通的城市；永贵已进入华为、西门子(中国)、阿尔斯通、三菱、日立、东洋、GE(中国)、奇瑞、比亚迪、江淮、宇通等品牌的供应链体系。公司总部位于浙江天台，目前拥有3家全资子公司，4家控股子公司，在浙江总部、四川绵阳、北京、深圳、江苏、重庆均设有生产基地和研发中心，公司还与清华大学、浙江大学、铁科院等多所大院名校建立了产学研合作关系。公司产品已获得了449项国家专利授权，先后通过了ISO9001认证、ISO/TS22163认证、CRCC认证、ETL认证、UL等质量体系 and 产品质量认证。

四川永贵科技有限公司成立于2008年3月，注册资金1亿元，资产总值11.2亿元，系浙江永贵电器股份有限公司（股票代码：300351）的全资子公司。公司占地180余亩，厂房及办公面积18万余平方米；其中，建成区面积11万余平方米；在建二期项目58余亩，建筑面积7万余平方米；拥有各类研发、生产设备4500余台（套），是国家级高新技术企业、国家知识产权示范企业、国家级专精特新小巨人企业、国家绿色工厂，拥有自主的核心技术，能为国家重点装备业提供可靠连接器系列产品及技术服务，为互连系统提供整体解决方案的个性化产品公司。

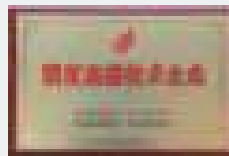

PATENT APPLICATION

专利申请

永贵在高速车载以太网连接器上已经授权的专利：

专利号及专利名称：

- 专利号：CN219979965U 专利名称：一种具有仿形内腔的连接器插头单元及连接器线缆组件；
- 专利号：CN219576012U 专利名称：一种连接器及连接器线缆组件；
- 专利号：CN219477065U 专利名称：一种用于插头连接器的固定系统；
- 专利号：CN219979882U 专利名称：一种车载连接器金属内部固持结构及车载连接器；
- 专利号：CN218731933U 专利名称：一种高速车载以太网的电连接器固定结构和电连接器；
- 专利号：CN219477037U 专利名称：一种用于汽车应用的差分对单元及连接；
- 专利号：CN220253544U 专利名称：一种车载连接器内部绝缘体固持结构及车载连接器；
- 专利号：CN220253545U 专利名称：一种车载连接器内部绝缘体结构及车载连接器；

· 证书展示 ·





科技连接未来
以客户为中心
实现价值最大化

CONTENTS

目录

HSED系列产品

● 产品简介	1
● 产品类型	1
● 选型配置表	2
● 技术参数	14
● 型号定义	15
● 连接器外形及尺寸	17
● 线缆组件接线图	27

附录：键位表

HSED系列连接器

产品简介

HSED是一种差分连接器系统，用于高达20 GHz的高速数据传输，主要应用领域为清摄像头、自动驾驶、车载激光雷达、高分辨率显示器、汽车后座娱乐系统等，HSED具有以下优点：

- 在保证高速率传输的条件下，具有更小的安装尺寸和更轻的质量；
- 具有1Pair(一对信号端子)、2Pair(两对信号端子)、4Pair(四对信号端子)、6Pair(六对信号端子)等多种腔体结构选择，满足客户不同的使用环境需求；
- 线缆组件支持带CPA版本，进一步增加连接的可靠性；
- 支持车载以太网协议、LVDS、PCIe Gen3等。

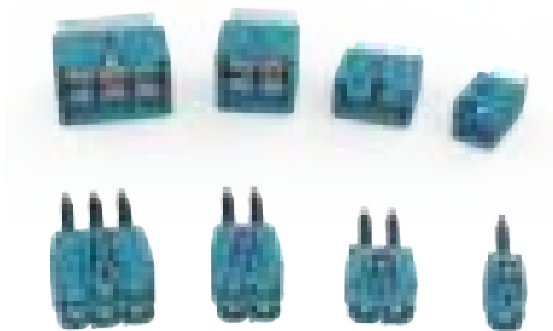

产品类型



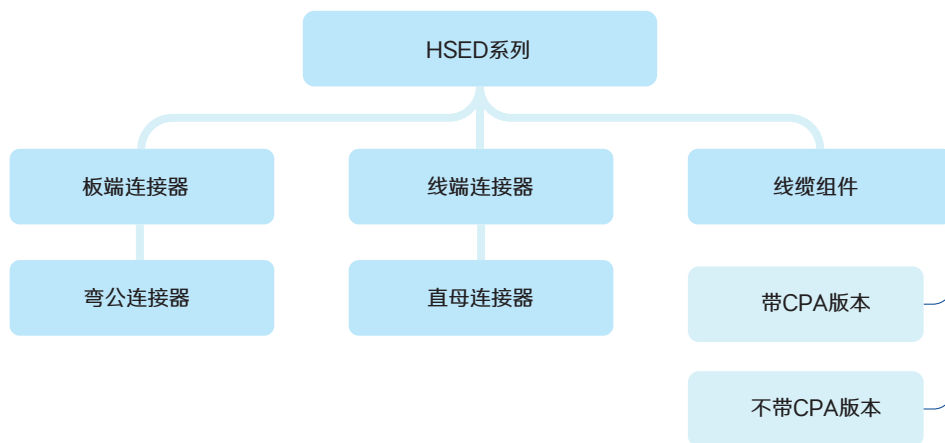





HSED系列目前有连接器和线缆组件两大类，其中连接器又分板端连接器和线端连接器。线缆组件根据是否带CPA，可以分为带CPA线缆组件和不带CPA线缆组件，详见下分类图：

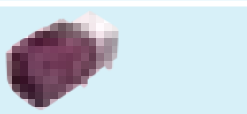
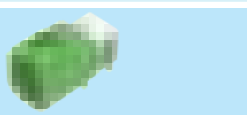
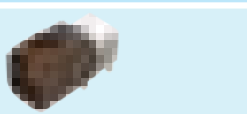

HSED系列连接器—选型配置表

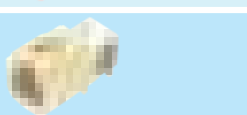
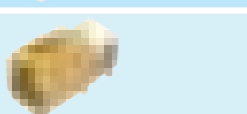
HSED板端连接器系列—通孔回流焊安装

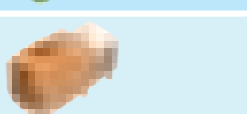
【1Pair板端——弯式插针】















产品型号	键位	备注	产品图片
YG1470-HSED-JA01RS01-A	见键位配置表	360°全屏蔽型 通孔回流焊安装 一对信号端子	
YG1470-HSED-JA01RS01-B			
YG1470-HSED-JA01RS01-C			
YG1470-HSED-JA01RS01-D			
YG1470-HSED-JA01RS01-E			
YG1470-HSED-JA01RS01-F			
YG1470-HSED-JA01RS01-G			
YG1470-HSED-JA01RS01-H			
YG1470-HSED-JA01RS01-J			
YG1470-HSED-JA01RS01-K			
YG1470-HSED-JA01RS01-L			
YG1470-HSED-JA01RS01-M			
YG1470-HSED-JA01RS01-O			
YG1470-HSED-JA01RS01-Z			

注：根据键位表中所列出的RAL颜色定义塑料外壳的颜色。由于制造的原因，可能会有轻微的颜色差异。

HSED系列连接器-选型配置表

HSED板端连接器系列—通孔回流焊安装

【2Pair板端——弯式插针】













产品型号	键位	备注	产品图片
YG1470-HSED-JA02RS01-A	见键位配置表	360°全屏蔽型 通孔回流焊安装 两对信号端子	
YG1470-HSED-JA02RS01-B			
YG1470-HSED-JA02RS01-C			
YG1470-HSED-JA02RS01-D			
YG1470-HSED-JA02RS01-E			
YG1470-HSED-JA02RS01-F			
YG1470-HSED-JA02RS01-G			
YG1470-HSED-JA02RS01-H			
YG1470-HSED-JA02RS01-J			
YG1470-HSED-JA02RS01-K			
YG1470-HSED-JA02RS01-L			
YG1470-HSED-JA02RS01-M			
YG1470-HSED-JA02RS01-O			
YG1470-HSED-JA02RS01-Z			

注：根据键位表中所列出的RAL颜色定义塑料外壳的颜色。由于制造的原因，可能会有轻微的颜色差异。

HSED系列连接器—选型配置表

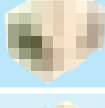
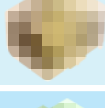
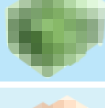
HSED板端连接器系列—通孔回流焊安装

【4Pair板端——弯式插针】















产品型号	键位	备注	产品图片
YG1470-HSED-JA04RS01-A	见键位配置表	360°全屏蔽型 通孔回流焊安装 四对信号端子	
YG1470-HSED-JA04RS01-B			
YG1470-HSED-JA04RS01-C			
YG1470-HSED-JA04RS01-D			
YG1470-HSED-JA04RS01-E			
YG1470-HSED-JA04RS01-F			
YG1470-HSED-JA04RS01-G			
YG1470-HSED-JA04RS01-H			
YG1470-HSED-JA04RS01-J			
YG1470-HSED-JA04RS01-K			
YG1470-HSED-JA04RS01-L			
YG1470-HSED-JA04RS01-M			
YG1470-HSED-JA04RS01-O			
YG1470-HSED-JA04RS01-Z			

注：根据键位表中所列出的RAL颜色定义塑料外壳的颜色。由于制造的原因，可能会有轻微的颜色差异。

HSED系列连接器—选型配置表

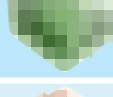
HSED板端连接器系列—通孔回流焊安装

【6Pair板端——弯式插针】















产品型号	键位	备注	产品图片
YG1470-HSED-JA06RS01-A	见键位配置表	360°全屏蔽型 通孔回流焊安装 六对信号端子	
YG1470-HSED-JA06RS01-B			
YG1470-HSED-JA06RS01-C			
YG1470-HSED-JA06RS01-D			
YG1470-HSED-JA06RS01-E			
YG1470-HSED-JA06RS01-F			
YG1470-HSED-JA06RS01-G			
YG1470-HSED-JA06RS01-H			
YG1470-HSED-JA06RS01-J			
YG1470-HSED-JA06RS01-K			
YG1470-HSED-JA06RS01-L			
YG1470-HSED-JA06RS01-M			
YG1470-HSED-JA06RS01-O			
YG1470-HSED-JA06RS01-Z			

注：根据键位表中所列出的RAL颜色定义塑料外壳的颜色。由于制造的原因，可能会有轻微的颜色差异。

HSED系列连接器—选型配置表

HSED线端连接器系列—压接安装

【1Pair线端——直式插孔 不带CPA】















产品型号	键位	备注	产品图片
YG1470-HSED-KA01SC01-A	见键位配置表	线缆压接安装 一对信号端子	
YG1470-HSED-KA01SC01-B			
YG1470-HSED-KA01SC01-C			
YG1470-HSED-KA01SC01-D			
YG1470-HSED-KA01SC01-E			
YG1470-HSED-KA01SC01-F			
YG1470-HSED-KA01SC01-G			
YG1470-HSED-KA01SC01-H			
YG1470-HSED-KA01SC01-J			
YG1470-HSED-KA01SC01-K			
YG1470-HSED-KA01SC01-L			
YG1470-HSED-KA01SC01-M			
YG1470-HSED-KA01SC01-O			
YG1470-HSED-KA01SC01-Z			

注：根据键位表中所列出的RAL颜色定义塑料外壳的颜色。由于制造的原因，可能会有轻微的颜色差异。

HSED系列连接器-选型配置表

HSED线端连接器系列—压接安装

【1Pair线端——直式插孔 带CPA】















产品型号	键位	备注	产品图片
YG1470-HSED-KA01SC02-A	见键位配置表	线缆压接安装 一对信号端子	
YG1470-HSED-KA01SC02-B			
YG1470-HSED-KA01SC02-C			
YG1470-HSED-KA01SC02-D			
YG1470-HSED-KA01SC02-E			
YG1470-HSED-KA01SC02-F			
YG1470-HSED-KA01SC02-G			
YG1470-HSED-KA01SC02-H			
YG1470-HSED-KA01SC02-J			
YG1470-HSED-KA01SC02-K			
YG1470-HSED-KA01SC02-L			
YG1470-HSED-KA01SC02-M			
YG1470-HSED-KA01SC02-O			
YG1470-HSED-KA01SC02-Z			

注：根据键位表中所列出的RAL颜色定义塑料外壳的颜色。由于制造的原因，可能会有轻微的颜色差异。

HSED系列连接器—选型配置表

HSED线端连接器系列—压接安装

【2Pair线端——直式插孔 不带CPA】















产品型号	键位	备注	产品图片
YG1470-HSED-KA02SC01-A	见键位配置表	线缆压接安装 两对信号端子	
YG1470-HSED-KA02SC01-B			
YG1470-HSED-KA02SC01-C			
YG1470-HSED-KA02SC01-D			
YG1470-HSED-KA02SC01-E			
YG1470-HSED-KA02SC01-F			
YG1470-HSED-KA02SC01-G			
YG1470-HSED-KA02SC01-H			
YG1470-HSED-KA02SC01-J			
YG1470-HSED-KA02SC01-K			
YG1470-HSED-KA02SC01-L			
YG1470-HSED-KA02SC01-M			
YG1470-HSED-KA02SC01-O			
YG1470-HSED-KA02SC01-Z			

注：根据键位表中所列出的RAL颜色定义塑料外壳的颜色。由于制造的原因，可能会有轻微的颜色差异。

HSED系列连接器-选型配置表

HSED线端连接器系列—压接安装

【2Pair线端——直式插孔 带CPA】











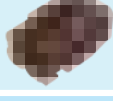

产品型号	键位	备注	产品图片
YG1470-HSED-KA02SC02-A	见键位配置表	线缆压接安装 两对信号端子	
YG1470-HSED-KA02SC02-B			
YG1470-HSED-KA02SC02-C			
YG1470-HSED-KA02SC02-D			
YG1470-HSED-KA02SC02-E			
YG1470-HSED-KA02SC02-F			
YG1470-HSED-KA02SC02-G			
YG1470-HSED-KA02SC02-H			
YG1470-HSED-KA02SC02-J			
YG1470-HSED-KA02SC02-K			
YG1470-HSED-KA02SC02-L			
YG1470-HSED-KA02SC02-M			
YG1470-HSED-KA02SC02-O			
YG1470-HSED-KA02SC02-Z			

注：根据键位表中所列出的RAL颜色定义塑料外壳的颜色。由于制造的原因，可能会有轻微的颜色差异。

HSED系列连接器—选型配置表

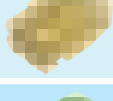
HSED线端连接器系列—压接安装

【4Pair线端——直式插孔 不带CPA】













产品型号	键位	备注	产品图片
YG1470-HSED-KA04SC01-A	见键位配置表	线缆压接安装 四对信号端子	
YG1470-HSED-KA04SC01-B			
YG1470-HSED-KA04SC01-C			
YG1470-HSED-KA04SC01-D			
YG1470-HSED-KA04SC01-E			
YG1470-HSED-KA04SC01-F			
YG1470-HSED-KA04SC01-G			
YG1470-HSED-KA04SC01-H			
YG1470-HSED-KA04SC01-J			
YG1470-HSED-KA04SC01-K			
YG1470-HSED-KA04SC01-L			
YG1470-HSED-KA04SC01-M			
YG1470-HSED-KA04SC01-O			
YG1470-HSED-KA04SC01-Z			

注：根据键位表中所列出的RAL颜色定义塑料外壳的颜色。由于制造的原因，可能会有轻微的颜色差异。

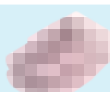
HSED系列连接器-选型配置表

HSED线端连接器系列—压接安装

【4Pair线端——直式插孔 带CPA】







产品型号	键位	备注	产品图片
YG1470-HSED-KA04SC02-A	见键位配置表	线缆压接安装 四对信号端子	
YG1470-HSED-KA04SC02-B			
YG1470-HSED-KA04SC02-C			
YG1470-HSED-KA04SC02-D			
YG1470-HSED-KA04SC02-E			
YG1470-HSED-KA04SC02-F			
YG1470-HSED-KA04SC02-G			
YG1470-HSED-KA04SC02-H			
YG1470-HSED-KA04SC02-J			
YG1470-HSED-KA04SC02-K			
YG1470-HSED-KA04SC02-L			
YG1470-HSED-KA04SC02-M			
YG1470-HSED-KA04SC02-O			
YG1470-HSED-KA04SC02-Z			

注：根据键位表中所列出的RAL颜色定义塑料外壳的颜色。由于制造的原因，可能会有轻微的颜色差异。

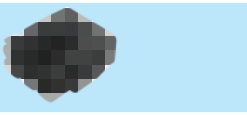
HSED系列连接器—选型配置表

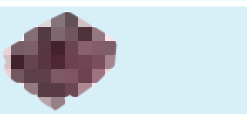
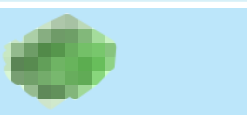
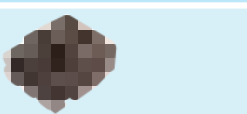
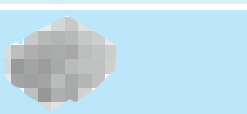
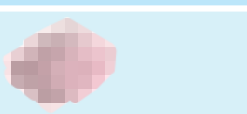
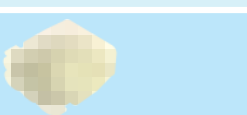
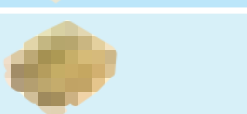
HSED线端连接器系列—压接安装

【6Pair线端——直式插孔 不带CPA】













产品型号	键位	备注	产品图片
YG1470-HSED-KA06SC01-A	见键位配置表	线缆压接安装 六对信号端子	
YG1470-HSED-KA06SC01-B			
YG1470-HSED-KA06SC01-C			
YG1470-HSED-KA06SC01-D			
YG1470-HSED-KA06SC01-E			
YG1470-HSED-KA06SC01-F			
YG1470-HSED-KA06SC01-G			
YG1470-HSED-KA06SC01-H			
YG1470-HSED-KA06SC01-J			
YG1470-HSED-KA06SC01-K			
YG1470-HSED-KA06SC01-L			
YG1470-HSED-KA06SC01-M			
YG1470-HSED-KA06SC01-O			
YG1470-HSED-KA06SC01-Z			

注：根据键位表中所列出的RAL颜色定义塑料外壳的颜色。由于制造的原因，可能会有轻微的颜色差异。

HSED系列连接器-选型配置表

HSED线端连接器系列—压接安装

【6Pair线端——直式插孔 带CPA】

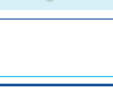
产品型号	键位	备注	产品图片
YG1470-HSED-KA06SC02-A	见键位配置表	线缆压接安装 六对信号端子	
YG1470-HSED-KA06SC02-B			
YG1470-HSED-KA06SC02-C			
YG1470-HSED-KA06SC02-D			
YG1470-HSED-KA06SC02-E			
YG1470-HSED-KA06SC02-F			
YG1470-HSED-KA06SC02-G			
YG1470-HSED-KA06SC02-H			
YG1470-HSED-KA06SC02-J			
YG1470-HSED-KA06SC02-K			
YG1470-HSED-KA06SC02-L			
YG1470-HSED-KA06SC02-M			
YG1470-HSED-KA06SC02-O			
YG1470-HSED-KA06SC02-Z			

注：根据键位表中所列出的RAL颜色定义塑料外壳的颜色。由于制造的原因，可能会有轻微的颜色差异。

技术参数

电气参数

接触电阻：内导体 $\leq 10\text{m}\Omega$ ，外导体 $\leq 7.5\text{m}\Omega$

绝缘电阻： $\geq 100\text{M}\Omega$

回损：DC to 10GHz

$\geq 30\text{dB}$, 0.01GHz to 3GHz

$\geq 25\text{dB}$, 3GHz to 6GHz

$\geq 20\text{dB}$, 6GHz to 10GHz

其他参数

材质：

内导体：铜合金

外导体：锌合金；

绝缘体：LCP； 阻燃等级：V0

塑胶外壳：尼龙； 阻燃等级：V0

表面处理：

内导体：

接触部位：镀金

锡焊部位：镀锡

其它部位：镀镍

外导体：镀锡

机械参数

机械寿命：25次

总插入力： $\leq 20\text{N}$ (1Pair) $\leq 25\text{N}$ (2Pair)

$\leq 45\text{N}$ (4Pair) $\leq 75\text{N}$ (6Pair)

总拔出力： $\geq 110\text{N}$ (锁紧状态)

机械振动：满足IEC 60068-2-64(GB/T 2423.56) 谱A.3,序号1

机械冲击：满足IEC 60068-2-27(GB/T 2423.5) 安装在轮式车

辆(表A.1),每个方向1000次

环境参数

工作温度： $-40^{\circ}\text{C} \sim +105^{\circ}\text{C}$

湿度：95% (40°C时)

RoHS：满足

HSED系列连接器-型号定义

型号定义

【连接器型号定义】

	YG1470	-HSED	-J	A	04	R	S	01	-y
①内部代号									
②系列名称: 高速以太网数据									
③接触件形式: J: 插针 K: 插孔									
④防护性能: L: 防水 A: 非防水型									
⑤差分对数量: 一对差分对(1Pair): 01 两对差分对(2Pair): 02 四对差分对(4Pair): 04 六对差分对(6Pair): 06									
⑥连接器类型: 弯式: R 直式: S									
⑦端接类型: S: 焊接 C: 压线									
⑧扩展型号: 流水号									
⑨ 键位: y代表键位, y可以取A、B、C、D、E、F、G、H、J、K、L、M、O、Z, 每一个字母代表一个键位, 总共提供14种键位, 详见键位表。									

HSED系列连接器-型号定义

型号定义

【线缆组件型号定义】

	YG1470	-HSED	- XX	-1	01	-xxxx	-y	-y
① 内部代号								
② 系列名称:	高速以太网数据							
③ XX表示线缆类型:	CA: GG 2Speed@251 BZ: LEONI Dacar@647-4							
④ 差分对数量:	一对差分对: 1 两对差分对: 2 四对差分对: 3 六对差分对: 4							
⑤ 扩展型号:	流水号							
⑥ xxxx:	线缆长度, 单位mm							
⑦ A端连接器键位:	y代表键位, y可以取A、B、C、D、E、F、G、H、J、K、L、M、O、Z, 每一个字母代表一个键位, 总共提供14种键位, 详见键位表。							
⑧ B端连接器键位:	y代表键位, y可以取A、B、C、D、E、F、G、H、J、K、L、M、O、Z, 每一个字母代表一个键位, 总共提供14种键位, 详见键位表。							

HSED系列连接器-外形尺寸

连接器外形及安装尺寸

【1Pair板端——弯式插针 外形尺寸】

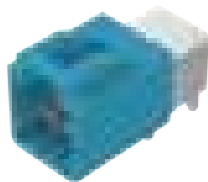

1Pair板端外形

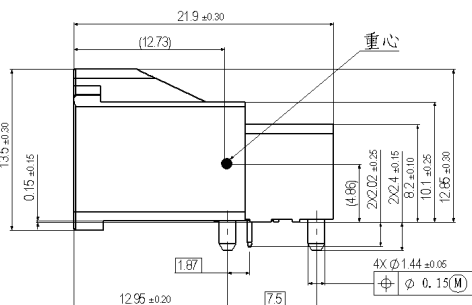
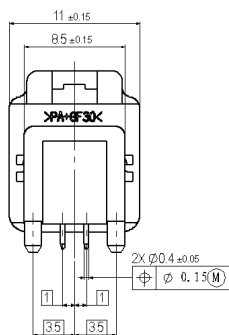

1Pair板端外形尺寸

【1Pair板端——弯式插针 推荐PCB尺寸】

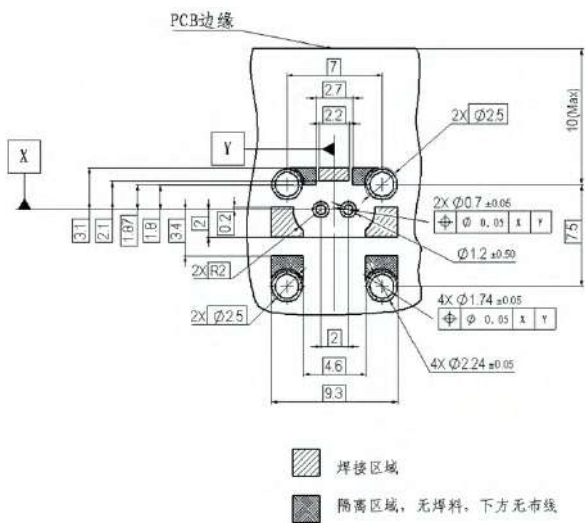
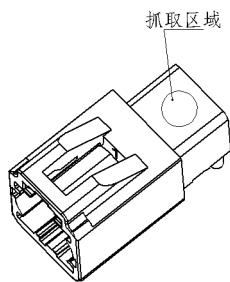

产品型号	
YG1470-HSED-JA01RS01-A	YG1470-HSED-JA01RS01-G
YG1470-HSED-JA01RS01-B	YG1470-HSED-JA01RS01-H
YG1470-HSED-JA01RS01-C	YG1470-HSED-JA01RS01-J
YG1470-HSED-JA01RS01-D	YG1470-HSED-JA01RS01-K
YG1470-HSED-JA01RS01-E	YG1470-HSED-JA01RS01-L
YG1470-HSED-JA01RS01-F	YG1470-HSED-JA01RS01-M
YG1470-HSED-JA01RS01-Z	YG1470-HSED-JA01RS01-O

注：上图只显示Z键位产品，其它键位产品外形尺寸相同

HSED系列连接器-外形尺寸

连接器外形及安装尺寸

【2Pair板端——弯式插针 外形尺寸】

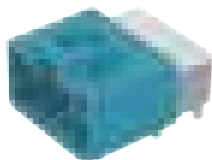

2Pair板端外形

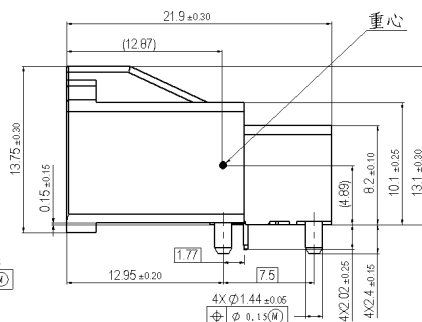
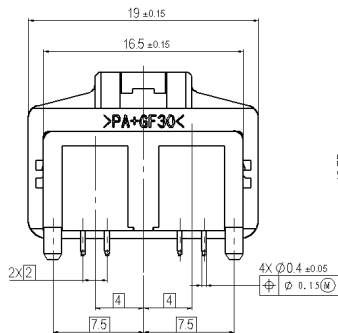

2Pair板端外形尺寸

【2Pair板端——弯式插针 推荐PCB尺寸】

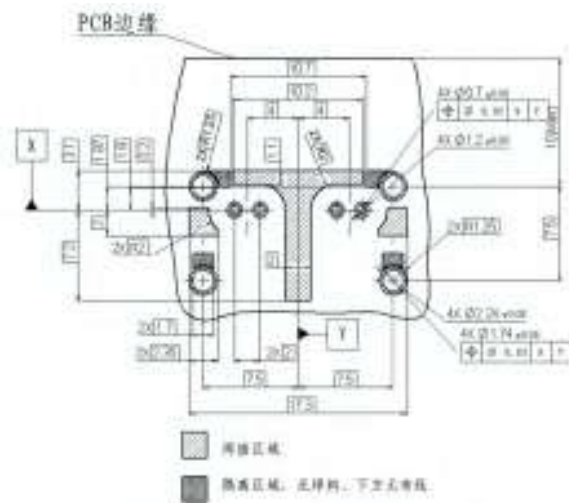
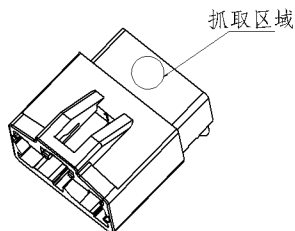

产品型号

YG1470-HSED-JA02RS01-A

YG1470-HSED-JA02RS01-G

YG1470-HSED-JA02RS01-B

YG1470-HSED-JA02RS01-H

YG1470-HSED-JA02RS01-C

YG1470-HSED-JA02RS01-J

YG1470-HSED-JA02RS01-D

YG1470-HSED-JA02RS01-K

YG1470-HSED-JA02RS01-E

YG1470-HSED-JA02RS01-L

YG1470-HSED-JA02RS01-F

YG1470-HSED-JA02RS01-M

YG1470-HSED-JA02RS01-Z

YG1470-HSED-JA02RS01-O

注：上图只显示Z键位产品，其它键位产品外形尺寸相同

HSED系列连接器-外形尺寸

连接器外形及安装尺寸

【4Pair板端——弯式插针 外形尺寸】

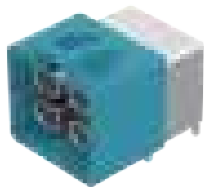

4Pair板端外形

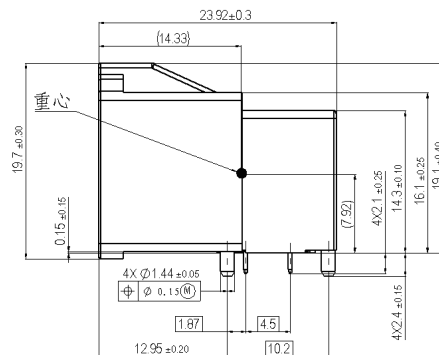
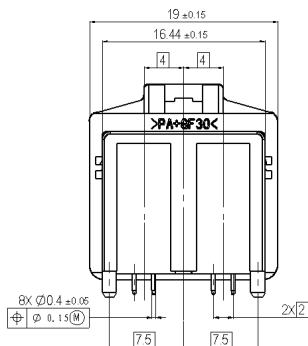

4Pair板端外形尺寸

【4Pair板端——弯式插针 推荐PCB尺寸】

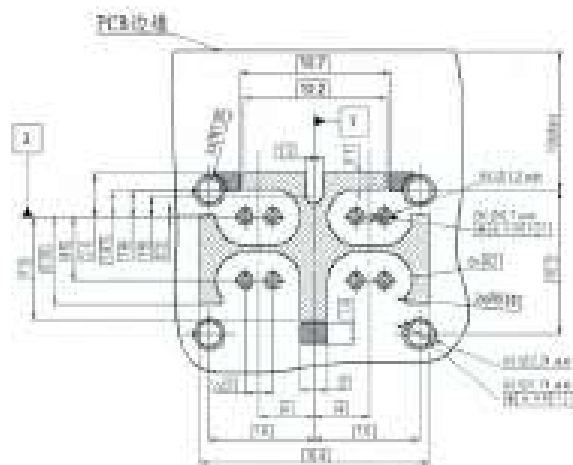
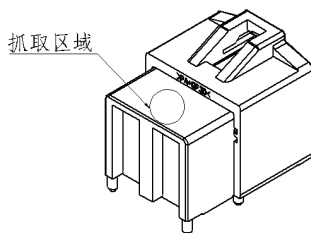

▨ 焊接区域

■ 隔离区域, 无焊料, 下方无布线

产品型号

YG1470-HSED-JA04RS01-A

YG1470-HSED-JA04RS01-B

YG1470-HSED-JA04RS01-C

YG1470-HSED-JA04RS01-D

YG1470-HSED-JA04RS01-E

YG1470-HSED-JA04RS01-F

YG1470-HSED-JA04RS01-Z

YG1470-HSED-JA04RS01-G

YG1470-HSED-JA04RS01-H

YG1470-HSED-JA04RS01-J

YG1470-HSED-JA04RS01-K

YG1470-HSED-JA04RS01-L

YG1470-HSED-JA04RS01-M

YG1470-HSED-JA04RS01-O

注: 上图只显示Z键位产品, 其它键位产品外形尺寸相同

HSED系列连接器-外形尺寸

连接器外形及安装尺寸

【6Pair板端——弯式插针 外形尺寸】

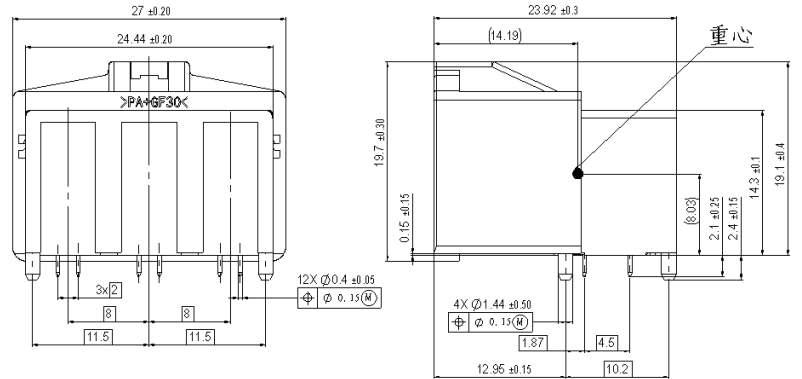
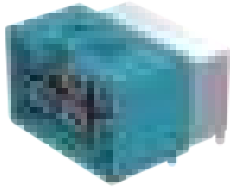

6Pair板端外形

6Pair板端外形尺寸

【6Pair板端——弯式插针 推荐PCB尺寸】

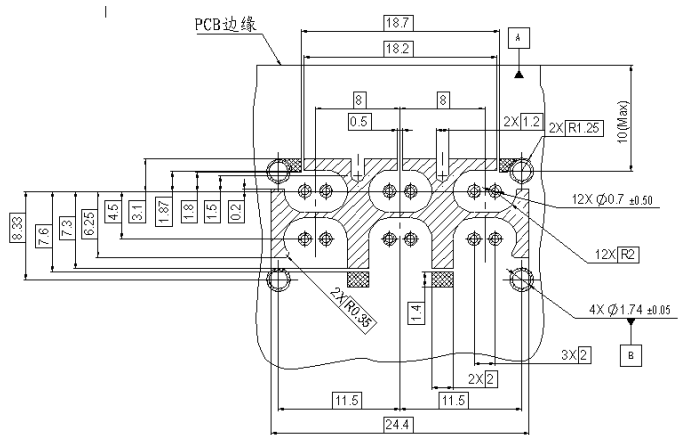
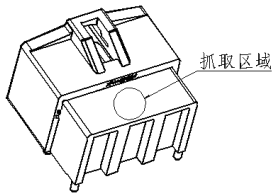

■ 焊接区域
■ 隔离区域，无焊料，下方无布线

产品型号

YG1470-HSED-JA06RS01-A	YG1470-HSED-JA06RS01-G
YG1470-HSED-JA06RS01-B	YG1470-HSED-JA06RS01-H
YG1470-HSED-JA06RS01-C	YG1470-HSED-JA06RS01-J
YG1470-HSED-JA06RS01-D	YG1470-HSED-JA06RS01-K
YG1470-HSED-JA06RS01-E	YG1470-HSED-JA06RS01-L
YG1470-HSED-JA06RS01-F	YG1470-HSED-JA06RS01-M
YG1470-HSED-JA06RS01-Z	YG1470-HSED-JA06RS01-O

注：上图只显示Z键位产品，其它键位产品外形尺寸相同

HSED系列连接器-外形尺寸

连接器外形及安装尺寸

【1Pair线端——直式插孔 外形尺寸(不带CPA)】

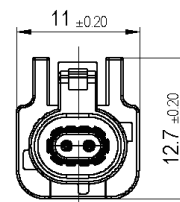
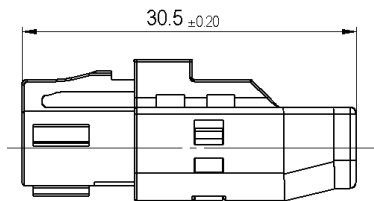

产品型号		适用线缆类型	接线方式
YG1470-HSED-JA06RS01-A	YG1470-HSED-JA06RS01-G	GG 2Speed® 251 LEONI Dacar® 647-4	压接
YG1470-HSED-JA06RS01-B	YG1470-HSED-JA06RS01-H		
YG1470-HSED-JA06RS01-C	YG1470-HSED-JA06RS01-J		
YG1470-HSED-JA06RS01-D	YG1470-HSED-JA06RS01-K		
YG1470-HSED-JA06RS01-E	YG1470-HSED-JA06RS01-L		
YG1470-HSED-JA06RS01-F	YG1470-HSED-JA06RS01-M		
YG1470-HSED-JA06RS01-Z	YG1470-HSED-JA06RS01-O		

注：上图只显示Z键位产品，其它键位产品外形尺寸相同

【1Pair线端——直式插孔 外形尺寸(带CPA)】

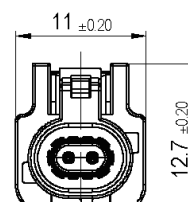
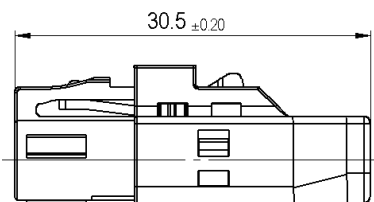

产品型号		适用线缆类型	接线方式
YG1470-HSED-KA01SC02-A	YG1470-HSED-KA01SC02-G	GG 2Speed® 251 LEONI Dacar® 647-4	压接
YG1470-HSED-KA01SC02-B	YG1470-HSED-KA01SC02-H		
YG1470-HSED-KA01SC02-C	YG1470-HSED-KA01SC02-J		
YG1470-HSED-KA01SC02-D	YG1470-HSED-KA01SC02-K		
YG1470-HSED-KA01SC02-E	YG1470-HSED-KA01SC02-L		
YG1470-HSED-KA01SC02-F	YG1470-HSED-KA01SC02-M		
YG1470-HSED-KA01SC02-Z	YG1470-HSED-KA01SC02-O		

注：上图只显示Z键位产品，其它键位产品外形尺寸相同

HSED系列连接器-外形尺寸

连接器外形及安装尺寸

【2Pair线端——直式插孔 外形尺寸(不带CPA)】

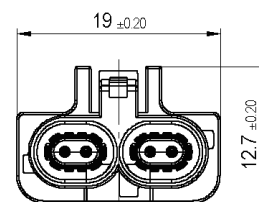
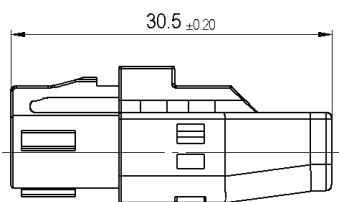
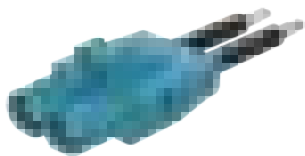

产品型号		适用线缆类型	接线方式
YG1470-HSED-KA02SC01-A	YG1470-HSED-KA02SC01-G	GG 2Speed® 251 LEONI Dacar® 647-4	压接
YG1470-HSED-KA02SC01-B	YG1470-HSED-KA02SC01-H		
YG1470-HSED-KA02SC01-C	YG1470-HSED-KA02SC01-J		
YG1470-HSED-KA02SC01-D	YG1470-HSED-KA02SC01-K		
YG1470-HSED-KA02SC01-E	YG1470-HSED-KA02SC01-L		
YG1470-HSED-KA02SC01-F	YG1470-HSED-KA02SC01-M		
YG1470-HSED-KA02SC01-Z	YG1470-HSED-KA02SC01-O		

注：上图只显示Z键位产品，其它键位产品外形尺寸相同

【2Pair线端——直式插孔 外形尺寸(带CPA)】

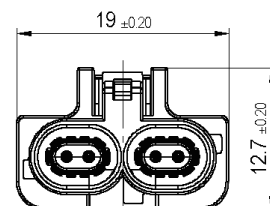
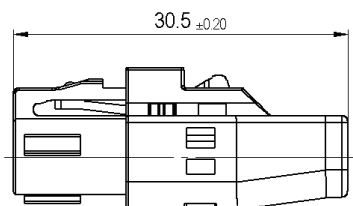

产品型号		适用线缆类型	接线方式
YG1470-HSED-KA02SC02-A	YG1470-HSED-KA02SC02-G	GG 2Speed® 251 LEONI Dacar® 647-4	压接
YG1470-HSED-KA02SC02-B	YG1470-HSED-KA02SC02-H		
YG1470-HSED-KA02SC02-C	YG1470-HSED-KA02SC02-J		
YG1470-HSED-KA02SC02-D	YG1470-HSED-KA02SC02-K		
YG1470-HSED-KA02SC02-E	YG1470-HSED-KA02SC02-L		
YG1470-HSED-KA02SC02-F	YG1470-HSED-KA02SC02-M		
YG1470-HSED-KA02SC02-Z	YG1470-HSED-KA02SC02-O		

注：上图只显示Z键位产品，其它键位产品外形尺寸相同

HSED系列连接器-外形尺寸

连接器外形及安装尺寸

【4Pair线端——直式插孔 外形尺寸(不带CPA)】

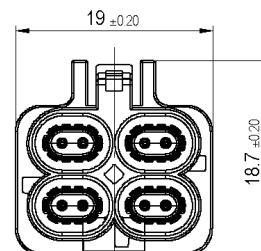
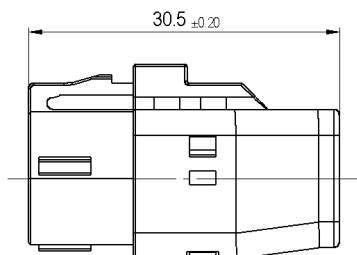
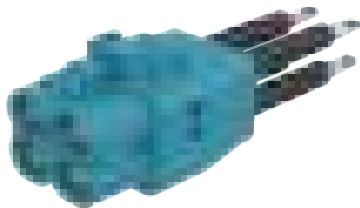

产品型号		适用线缆类型	接线方式
YG1470-HSED-KA04SC01-A	YG1470-HSED-KA04SC01-G	GG 2Speed® 251 LEONI Dacar® 647-4	压接
YG1470-HSED-KA04SC01-B	YG1470-HSED-KA04SC01-H		
YG1470-HSED-KA04SC01-C	YG1470-HSED-KA04SC01-J		
YG1470-HSED-KA04SC01-D	YG1470-HSED-KA04SC01-K		
YG1470-HSED-KA04SC01-E	YG1470-HSED-KA04SC01-L		
YG1470-HSED-KA04SC01-F	YG1470-HSED-KA04SC01-M		
YG1470-HSED-KA04SC01-Z	YG1470-HSED-KA04SC01-O		

注：上图只显示Z键位产品，其它键位产品外形尺寸相同

【4Pair线端——直式插孔 外形尺寸(带CPA)】

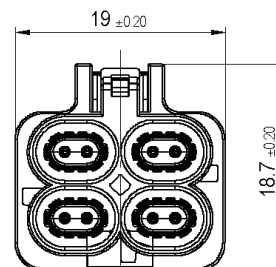
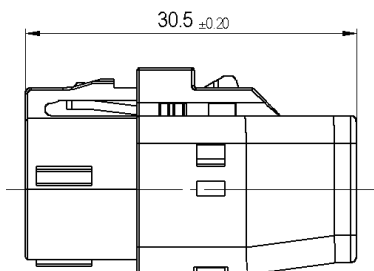

产品型号		适用线缆类型	接线方式
YG1470-HSED-KA04SC02-A	YG1470-HSED-KA04SC02-G	GG 2Speed® 251 LEONI Dacar® 647-4	压接
YG1470-HSED-KA04SC02-B	YG1470-HSED-KA04SC02-H		
YG1470-HSED-KA04SC02-C	YG1470-HSED-KA04SC02-J		
YG1470-HSED-KA04SC02-D	YG1470-HSED-KA04SC02-K		
YG1470-HSED-KA04SC02-E	YG1470-HSED-KA04SC02-L		
YG1470-HSED-KA04SC02-F	YG1470-HSED-KA04SC02-M		
YG1470-HSED-KA04SC02-Z	YG1470-HSED-KA04SC02-O		

注：上图只显示Z键位产品，其它键位产品外形尺寸相同

HSED系列连接器-外形尺寸

连接器外形及安装尺寸

【6Pair线端——直式插孔 外形尺寸(不带CPA)】

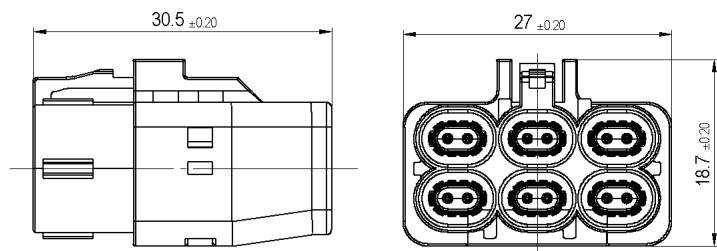
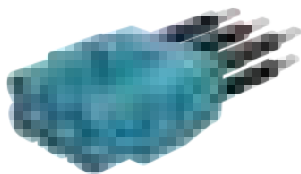

产品型号		适用线缆类型	接线方式
YG1470-HSED-KA06SC01-A	YG1470-HSED-KA06SC01-G	GG 2Speed® 251 LEONI Dacar® 647-4	压接
YG1470-HSED-KA06SC01-B	YG1470-HSED-KA06SC01-H		
YG1470-HSED-KA06SC01-C	YG1470-HSED-KA06SC01-J		
YG1470-HSED-KA06SC01-D	YG1470-HSED-KA06SC01-K		
YG1470-HSED-KA06SC01-E	YG1470-HSED-KA06SC01-L		
YG1470-HSED-KA06SC01-F	YG1470-HSED-KA06SC01-M		
YG1470-HSED-KA06SC01-Z	YG1470-HSED-KA06SC01-O		

注：上图只显示Z键位产品，其它键位产品外形尺寸相同

【6Pair线端——直式插孔 外形尺寸(带CPA)】

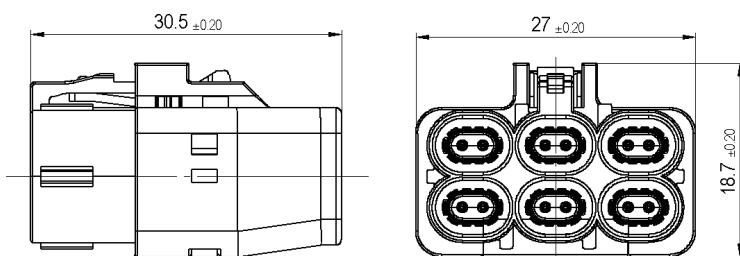
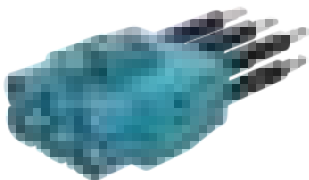

产品型号		适用线缆类型	接线方式
YG1470-HSED-KA06SC02-A	YG1470-HSED-KA06SC02-G	GG 2Speed® 251 LEONI Dacar® 647-4	压接
YG1470-HSED-KA06SC02-B	YG1470-HSED-KA06SC02-H		
YG1470-HSED-KA06SC02-C	YG1470-HSED-KA06SC02-J		
YG1470-HSED-KA06SC02-D	YG1470-HSED-KA06SC02-K		
YG1470-HSED-KA06SC02-E	YG1470-HSED-KA06SC02-L		
YG1470-HSED-KA06SC02-F	YG1470-HSED-KA06SC02-M		
YG1470-HSED-KA06SC02-Z	YG1470-HSED-KA06SC02-O		

注：上图只显示Z键位产品，其它键位产品外形尺寸相同

HSED系列连接器-外形尺寸

连接器外形及安装尺寸

【1Pair线缆组件(不带CPA)】

产品型号	线缆类型	备注	A端连接器型号	B端连接器型号	产品图片
YG1470-HSED-CCA-101-xxxx-y-y	CA: GG 2Speed® 251	xxxx: 表示线缆长度 -y-y: 分别表示A端连接器和B端连接器的键位	YG1470-HSED-KA01SC01-y	YG1470-HSED-KA01SC01-y	

【1Pair线缆组件(带CPA)】

产品型号	线缆类型	备注	A端连接器型号	B端连接器型号	产品图片
YG1470-HSED-CCA-102-xxxx-y-y	CA: GG 2Speed® 251	xxxx: 表示线缆长度 -y-y: 分别表示A端连接器和B端连接器的键位	YG1470-HSED-KA01SC02-y	YG1470-HSED-KA01SC02-y	

【2Pair线缆组件(不带CPA)】

产品型号	线缆类型	备注	A端连接器型号	B端连接器型号	产品图片
YG1470-HSED-CCA-201-xxxx-y-y	CA: GG 2Speed® 251	xxxx: 表示线缆长度 -y-y: 分别表示A端连接器和B端连接器的键位	YG1470-HSED-KA02SC01-y	YG1470-HSED-KA02SC01-y	

【2Pair线缆组件(带CPA)】

产品型号	线缆类型	备注	A端连接器型号	B端连接器型号	产品图片
YG1470-HSED-CCA-202-xxxx-y-y	CA: GG 2Speed® 251	xxxx: 表示线缆长度 -y-y: 分别表示A端连接器和B端连接器的键位	YG1470-HSED-KA02SC02-y	YG1470-HSED-KA02SC02-y	

HSED系列连接器-外形尺寸

连接器外形及安装尺寸

【4Pair线缆组件(不带CPA)】

产品型号	线缆类型	备注	A端连接器型号	B端连接器型号	产品图片
YG1470-HSED- CCA-401-xxxx-y-y	CA: GG 2Speed® 251	xxxx: 表示线缆长度 -y-y: 分别表示A端 连接器和B端连接器 的键位	YG1470-HSED- KA04SC01-y	YG1470-HSED- KA04SC01-y	

【4Pair线缆组件(带CPA)】

产品型号	线缆类型	备注	A端连接器型号	B端连接器型号	产品图片
YG1470-HSED- CCA-402-xxxx-y-y	CA: GG 2Speed® 251	xxxx: 表示线缆长度 -y-y: 分别表示A端 连接器和B端连接器 的键位	YG1470-HSED- KA04SC02-y	YG1470-HSED- KA04SC02-y	

【6Pair线缆组件(不带CPA)】

产品型号	线缆类型	备注	A端连接器型号	B端连接器型号	产品图片
YG1470-HSED- CCA-601-xxxx-y-y	CA: GG 2Speed® 251	xxxx: 表示线缆长度 -y-y: 分别表示A端 连接器和B端连接器 的键位	YG1470-HSED- KA06SC01-y	YG1470-HSED- KA06SC01-y	

【6Pair线缆组件(带CPA)】

产品型号	线缆类型	备注	A端连接器型号	B端连接器型号	产品图片
YG1470-HSED- CCA-602-xxxx-y-y	CA: GG 2Speed® 251	xxxx: 表示线缆长度 -y-y: 分别表示A端 连接器和B端连接器 的键位	YG1470-HSED- KA06SC02-y	YG1470-HSED- KA06SC02-y	

HSED系列连接器-线缆组件接线图

线缆组件接线图

【1Pair线缆组件(不带CPA)】

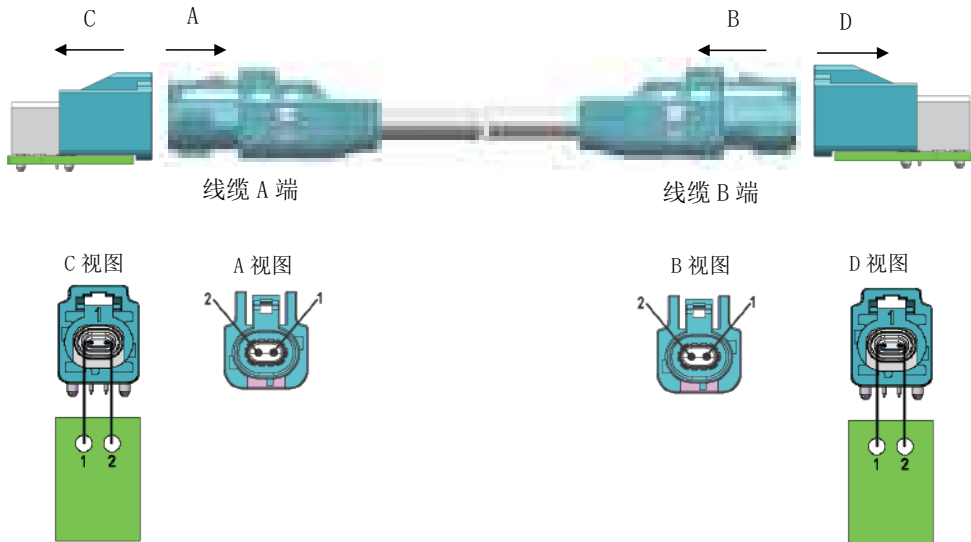

线缆接线关系表			
A视图		B视图	
1	●	●	1
2	●	●	2

【1Pair线缆组件(不带CPA)】

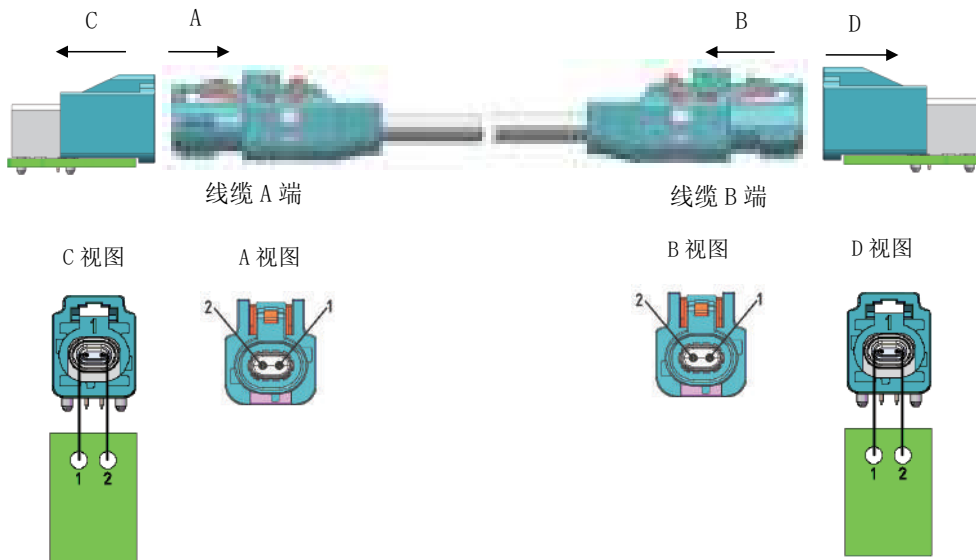

线缆接线关系表			
A视图		B视图	
1	●	●	1
2	●	●	2

HSED系列连接器-线缆组件接线图

线缆组件接线图

【2Pair线缆组件(不带CPA)】

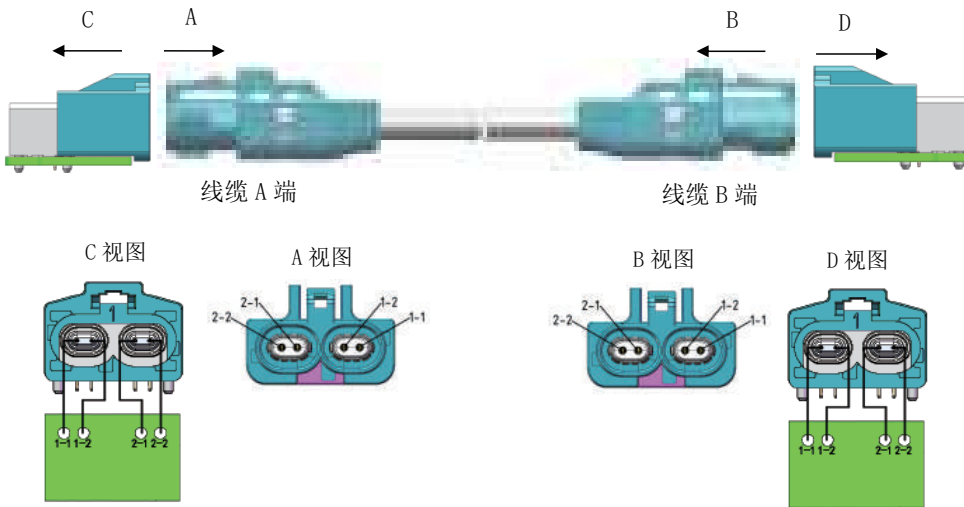

线缆接线关系表	
A视图	B视图
1-1 ●	● 1-1
1-2 ●	● 1-2
2-1 ●	● 2-1
2-2 ●	● 2-2

【2Pair线缆组件(带CPA)】

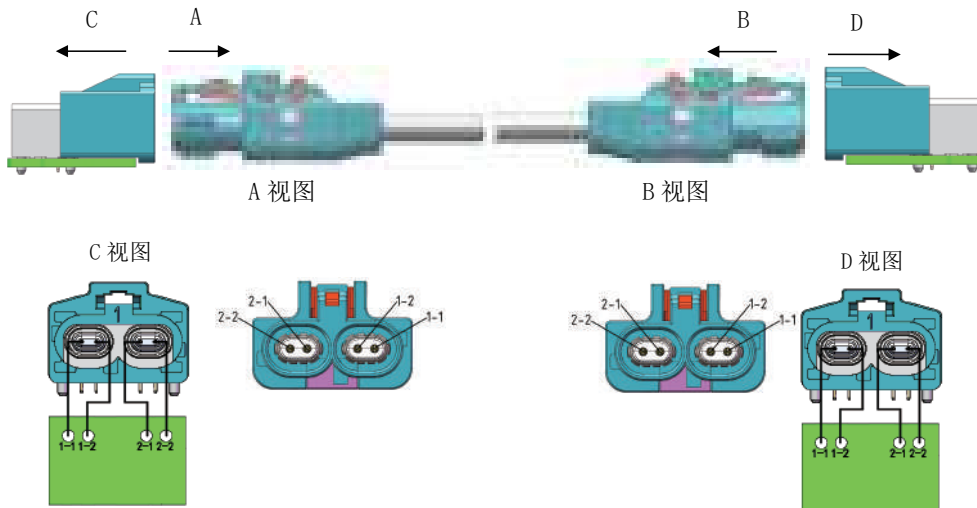

线缆接线关系表	
A视图	B视图
1-1 ●	● 1-1
1-2 ●	● 1-2
2-1 ●	● 2-1
2-2 ●	● 2-2

HSED系列连接器-线缆组件接线图

线缆组件接线图

【4Pair线缆组件(不带CPA)】

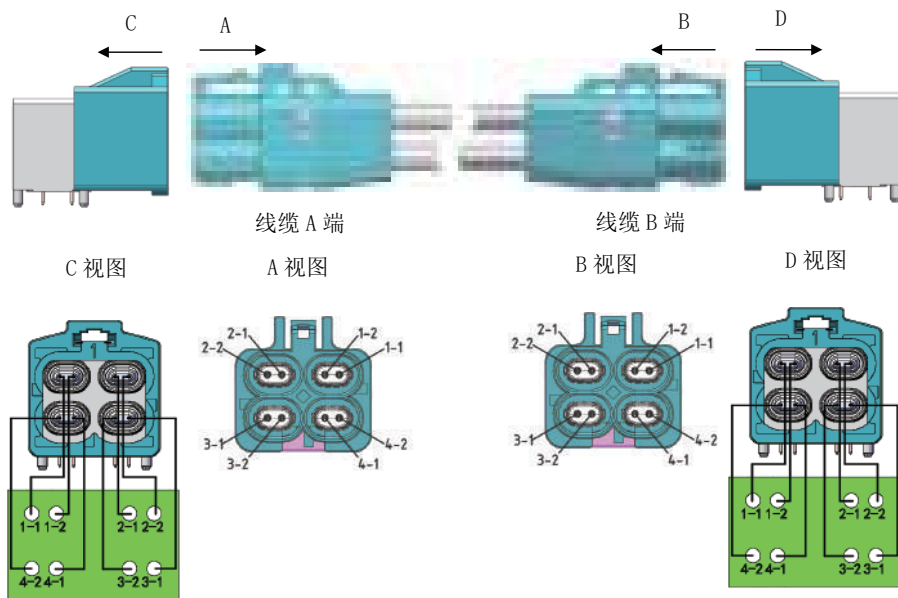

线缆接线关系表	
A视图	B视图
1-1	1-1
1-2	1-2
2-1	2-1
2-2	2-2
3-1	3-1
3-2	3-2
4-1	4-1
4-2	4-2

【4Pair线缆组件(带CPA)】

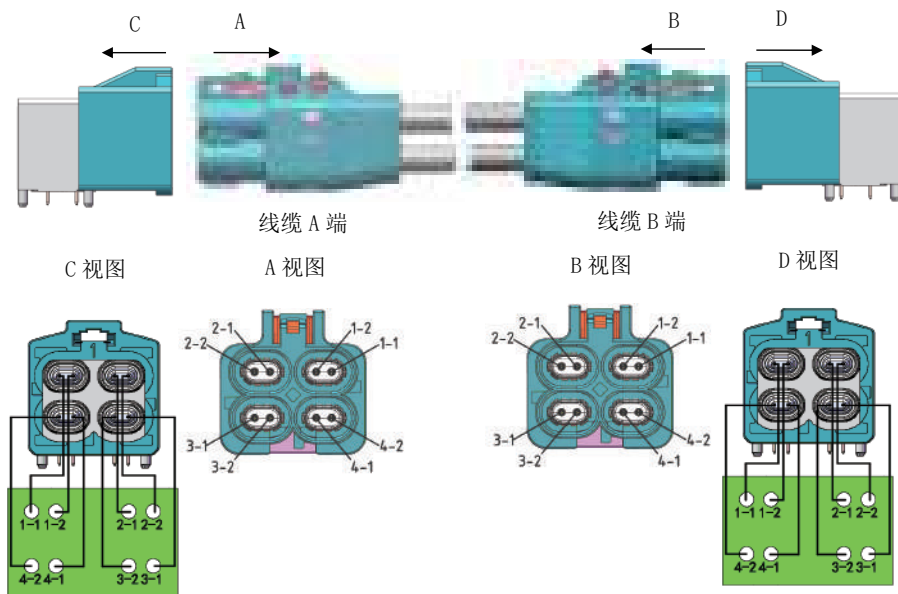

线缆接线关系表	
A视图	B视图
1-1	1-1
1-2	1-2
2-1	2-1
2-2	2-2
3-1	3-1
3-2	3-2
4-1	4-1
4-2	4-2

HSED系列连接器-线缆组件接线图

线缆组件接线图

【6Pair线缆组件(不带CPA)】

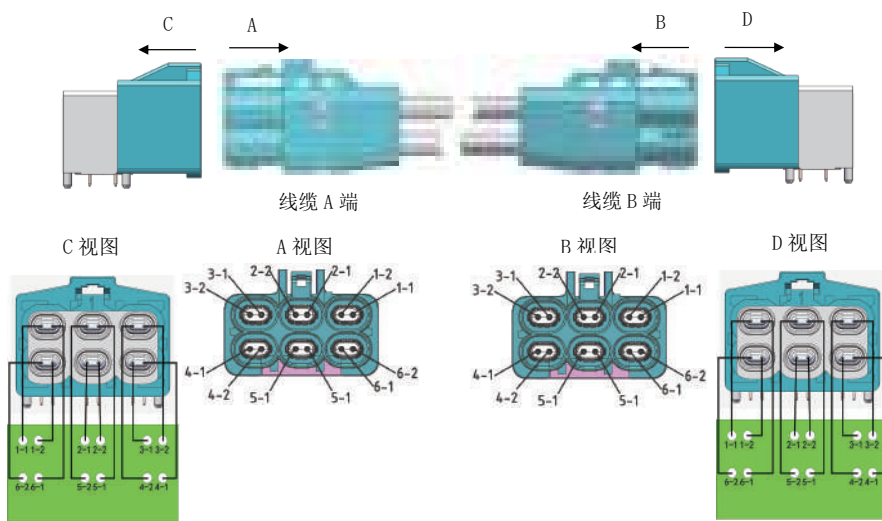

线缆接线关系表		
A视图		B视图
1-1	● ——— ●	1-1
1-2	● ——— ●	1-2
2-1	● ——— ●	2-1
2-2	● ——— ●	2-2
4-1	● ——— ●	4-1
4-2	● ——— ●	4-2
5-1	● ——— ●	5-1
5-2	● ——— ●	5-2
6-1	● ——— ●	6-1
6-2	● ——— ●	6-2

【6Pair线缆组件(带CPA)】

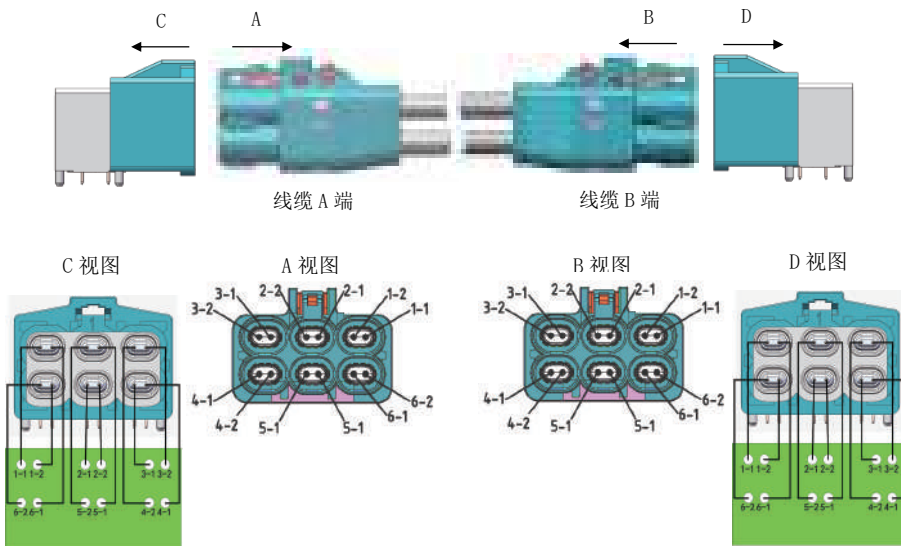





线缆接线关系表		
A视图		B视图
1-1	● ——— ●	1-1
1-2	● ——— ●	1-2
2-1	● ——— ●	2-1
2-2	● ——— ●	2-2
4-1	● ——— ●	4-1
4-2	● ——— ●	4-2
5-1	● ——— ●	5-1
5-2	● ——— ●	5-2
6-1	● ——— ●	6-1
6-2	● ——— ●	6-2

Appendix

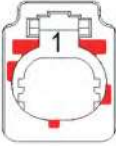
附录：键位表

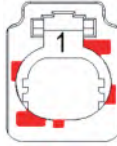
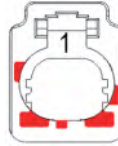
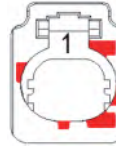
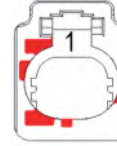
【1Pair板端——弯式插针】

键位编码	A	B	C	D	E	F	Z
键位图示							
颜色&色标	黑色 RAL9005	白色 RAL9010	淡蓝色 RAL5012	酒红紫 RAL4004	五月绿 RAL6017	深棕色 RAL8011	水蓝色 RAL5021
产品型号	YG1470-HSED- JA01RS01-A	YG1470-HSED- JA01RS01-B	YG1470-HSED- JA01RS01-C	YG1470-HSED- JA01RS01-D	YG1470-HSED- JA01RS01-E	YG1470-HSED- JA01RS01-F	YG1470-HSED- JA01RS01-Z

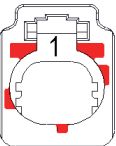
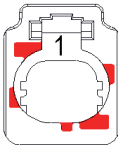
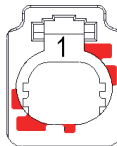
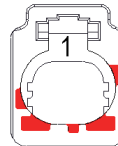
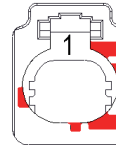
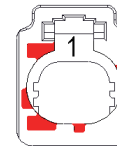
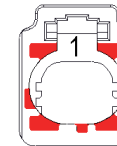
键位编码	G	H	J	K	L	M	O
键位图示							
颜色&色标	铂灰色 RAL7036	淡粉色 RAL3015	米色 RAL1001	咖喱色 RAL1027	黄绿色 RAL6018	淡橘色 RAL2003	淡绿色 RAL6027
产品型号	YG1470-HSED- JA01RS01-G	YG1470-HSED- JA01RS01-H	YG1470-HSED- JA01RS01-J	YG1470-HSED- JA01RS01-K	YG1470-HSED- JA01RS01-L	YG1470-HSED- JA01RS01-M	YG1470-HSED- JA01RS01-O

注：产品配色的标准为RAL标准。

【2Pair板端——弯式插针】

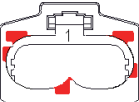
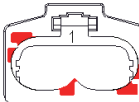
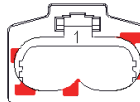
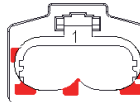
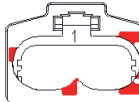
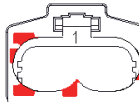
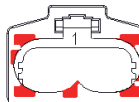
键位编码	A	B	C	D	E	F	Z
键位图示							
颜色&色标	黑色 RAL9005	白色 RAL9010	淡蓝色 RAL5012	酒红紫 RAL4004	五月绿 RAL6017	深棕色 RAL8011	水蓝色 RAL5021
产品型号	YG1470-HSED- KAD2SC01-A	YG1470-HSED- KA02SC01-B	YG1470-HSED- KA02SC01-C	YG1470-HSED- KA02SC01-D	YG1470-HSED- KA02SC01-E	YG1470-HSED- KA02SC01-F	YG1470-HSED- KA02SC01-Z

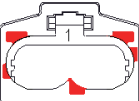
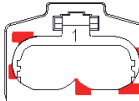
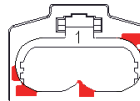
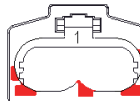
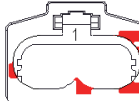
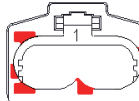
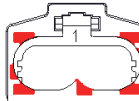
键位编码	G	H	J	K	L	M	O
键位图示							
颜色&色标	铂灰色 RAL7036	淡粉色 RAL3015	米色 RAL1001	咖喱色 RAL1027	黄绿色 RAL6018	淡橘色 RAL2003	淡绿色 RAL6027
产品型号	YG1470-HSED- JA02RS01-G	YG1470-HSED- JA02RS01-H	YG1470-HSED- JA02RS01-J	YG1470-HSED- JA02RS01-K	YG1470-HSED- JA02RS01-L	YG1470-HSED- JA02RS01-M	YG1470-HSED- JA02RS01-O

注：产品配色的标准为RAL标准。

【产品型号以及键位】

【4Pair板端——弯式插针】

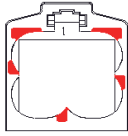
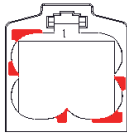
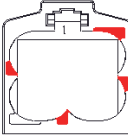
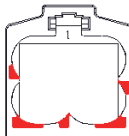
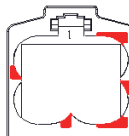
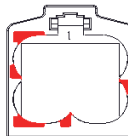
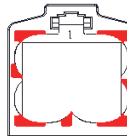
键位编码	A	B	C	D	E	F	Z
键位图示							
颜色&色标	黑色 RAL9005	白色 RAL9010	淡蓝色 RAL5012	酒红紫 RAL4004	五月绿 RAL6017	深棕色 RAL8011	水蓝色 RAL5021
产品型号	YG1470-HSED- JA04RS01-A	YG1470-HSED- JA04RS01-B	YG1470-HSED- JA04RS01-C	YG1470-HSED- JA04RS01-D	YG1470-HSED- JA04RS01-E	YG1470-HSED- JA04RS01-F	YG1470-HSED- JA04RS01-Z

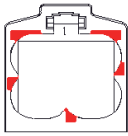
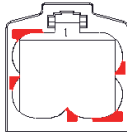
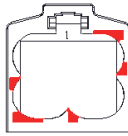
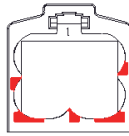
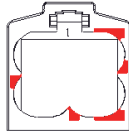
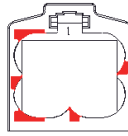
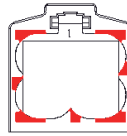
键位编码	G	H	J	K	L	M	O
键位图示							
颜色&色标	铂灰色 RAL7036	淡粉色 RAL3015	米色 RAL1001	咖喱色 RAL1027	黄绿色 RAL6018	淡橘色 RAL2003	淡绿色 RAL6027
产品型号	YG1470-HSED- JA04RS01-G	YG1470-HSED- JA04RS01-H	YG1470-HSED- JA04RS01-J	YG1470-HSED- JA04RS01-K	YG1470-HSED- JA04RS01-L	YG1470-HSED- JA04RS01-M	YG1470-HSED- JA04RS01-O

注：产品配色的标准为RAL标准。

【6Pair板端——弯式插针】

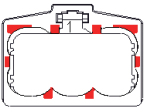
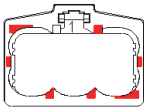
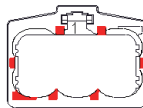
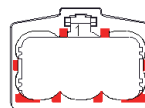
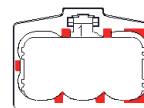
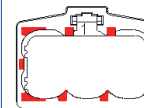
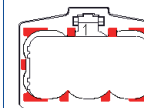
键位编码	A	B	C	D	E	F	Z
键位图示							
颜色&色标	黑色 RAL9005	白色 RAL9010	淡蓝色 RAL5012	酒红紫 RAL4004	五月绿 RAL6017	深棕色 RAL8011	水蓝色 RAL5021
产品型号	YG1470-HSED- JA06RS01-A	YG1470-HSED- JA06RS01-B	YG1470-HSED- JA06RS01-C	YG1470-HSED- JA06RS01-D	YG1470-HSED- JA06RS01-E	YG1470-HSED- JA06RS01-F	YG1470-HSED- JA06RS01-Z

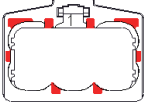
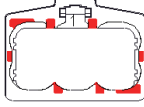
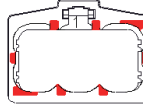
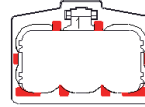
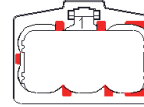
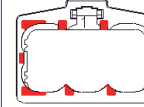
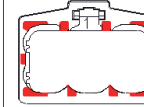





键位编码	G	H	J	K	L	M	O
键位图示							
颜色&色标	铂灰色 RAL7036	淡粉色 RAL3015	米色 RAL1001	咖喱色 RAL1027	黄绿色 RAL6018	淡橘色 RAL2003	淡绿色 RAL6027
产品型号	YG1470-HSED- JA06RS01-G	YG1470-HSED- JA06RS01-H	YG1470-HSED- JA06RS01-J	YG1470-HSED- JA06RS01-K	YG1470-HSED- JA06RS01-L	YG1470-HSED- JA06RS01-M	YG1470-HSED- JA06RS01-O





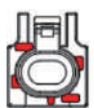

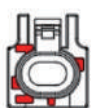
注：产品配色的标准为RAL标准。

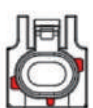
Appendix

附录：键位表







【1Pair线端——直式插孔(不带CPA)】







键位编码	A	B	C	D	E	F	Z
键位图示							
颜色&色标	黑色 RAL9005	白色 RAL9010	淡蓝色 RAL5012	酒红紫 RAL4004	五月绿 RAL6017	深棕色 RAL8011	水蓝色 RAL5021
产品型号	YG1470-HSED- KA01SC01-A	YG1470-HSED- KA01SC01-B	YG1470-HSED- KA01SC01-C	YG1470-HSED- KA01SC01-D	YG1470-HSED- KA01SC01-E	YG1470-HSED- KAD1SC01-F	YG1470-HSED- KA01SC01-Z

键位编码	G	H	J	K	L	M	O
键位图示							
颜色&色标	铂灰色 RAL7036	淡粉色 RAL3015	米色 RAL1001	咖喱色 RAL1027	黄绿色 RAL6018	淡橘色 RAL2003	淡绿色 RAL6027
产品型号	YG1470-HSED- KA01SC01-G	YG1470-HSED- KA01SC01-H	YG1470-HSED- KA01SC01-J	YG1470-HSED- KA01SC01-K	YG1470-HSED- KA01SC01-L	YG1470-HSED- KA01SC01-M	YG1470-HSED- KA01SC01-O

注：产品配色的标准为RAL标准。

【1Pair线端——直式插孔(带CPA)】

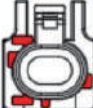





键位编码	A	B	C	D	E	F	Z
键位图示							
颜色&色标	黑色 RAL9005	白色 RAL9010	淡蓝色 RAL5012	酒红紫 RAL4004	五月绿 RAL6017	深棕色 RAL8011	水蓝色 RAL5021
产品型号	YG1470-HSED- KA01SC02-A	YG1470-HSED- KA01SC02-B	YG1470-HSED- KA01SC02-C	YG1470-HSED- KA01SC02-D	YG1470-HSED- KA01SC02-E	YG1470-HSED- KA01SC02-F	YG1470-HSED- KA01SC02-Z







键位编码	G	H	J	K	L	M	O
键位图示							
颜色&色标	铂灰色 RAL7036	淡粉色 RAL3015	米色 RAL1001	咖喱色 RAL1027	黄绿色 RAL6018	淡橘色 RAL2003	淡绿色 RAL6027
产品型号	YG1470-HSED- KA01SC02-G	YG1470-HSED- KA01SC02-H	YG1470-HSED- KA01SC02-J	YG1470-HSED- KA01SC02-K	YG1470-HSED- KA01SC02-L	YG1470-HSED- KA01SC02-M	YG1470-H21-0 KA01SC01-O

注：产品配色的标准为RAL标准。

【产品型号以及键位】

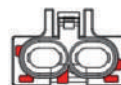





【2Pair线端——直式插孔(不带CPA)】







键位编码	A	B	C	D	E	F	Z
键位图示							
颜色&色标	黑色 RAL9005	白色 RAL9010	淡蓝色 RAL5012	酒红紫 RAL4004	五月绿 RAL6017	深棕色 RAL8011	水蓝色 RAL5021
产品型号	YG1470-HSED- KA02SC01-A	YG1470-HSED- KA02SC01-B	YG1470-HSED- KA02SC01-C	YG1470-HSED- KA02SC01-D	YG1470-HSED- KA02SC01-E	YG1470-HSED- KA02SC01-F	YG1470-HSED- KA02SC01-Z

键位编码	G	H	J	K	L	M	O
键位图示							
颜色&色标	铂灰色 RAL7036	淡粉色 RAL3015	米色 RAL1001	咖喱色 RAL1027	黄绿色 RAL6018	淡橘色 RAL2003	淡绿色 RAL6027
产品型号	YG1470-HSED- KA02SC01-G	YG1470-HSED- KA02SC01-H	YG1470-HSED- KA02SC01-J	YG1470-HSED- KA02SC01-K	YG1470-HSED- KA02SC01-L	YG1470-HSED- KA02SC01-M	YG1470-HSED- KA02SC01-O

注：产品配色的标准为RAL标准。

【2Pair线端——直式插孔(带CPA)】

键位编码	A	B	C	D	E	F	Z
键位图示							
颜色&色标	黑色 RAL9005	白色 RAL9010	淡蓝色 RAL5012	酒红紫 RAL4004	五月绿 RAL6017	深棕色 RAL8011	水蓝色 RAL5021
产品型号	YG1470-HSED- KA02SC02-A	YG1470-HSED- KA02SC02-B	YG1470-HSED- KA02SC02-C	YG1470-HSED- KA02SC02-D	YG1470-HSED- KA02SC02-E	YG1470-HSED- KA02SC02-F	YG1470-HSED- KA02SC02-Z

键位编码	G	H	J	K	L	M	O
键位图示							
颜色&色标	铂灰色 RAL7036	淡粉色 RAL3015	米色 RAL1001	咖喱色 RAL1027	黄绿色 RAL6018	淡橘色 RAL2003	淡绿色 RAL6027
产品型号	YG1470-HSED- KA02SC02-G	YG1470-HSED- KA02SC02-H	YG1470-HSED- KA02SC02-J	YG1470-HSED- KA02SC02-K	YG1470-HSED- KA02SC02-L	YG1470-HSED- KA02SC02-M	YG1470-HSED- KA02SC02-O

注：产品配色的标准为RAL标准。

Appendix

附录：键位表

【4Pair线端——直式插孔(不带CPA)】

键位编码	A	B	C	D	E	F	Z
键位图示							
颜色&色标	黑色 RAL9005	白色 RAL9010	淡蓝色 RAL5012	酒红紫 RAL4004	五月绿 RAL6017	深棕色 RAL8011	水蓝色 RAL5021
产品型号	YG1470-HSED- KA04SC01-A	YG1470-HSED- KA04SC01-B	YG1470-HSED- KA04SC01-C	YG1470-HSED- KA04SC01-D	YG1470-HSED- KA04SC01-E	YG1470-HSED- KA04SC01-F	YG1470-HSED- KA04SC01-Z

键位编码	G	H	J	K	L	M	O
键位图示							
颜色&色标	铂灰色 RAL7036	淡粉色 RAL3015	米色 RAL1001	咖喱色 RAL1027	黄绿色 RAL6018	淡橘色 RAL2003	淡绿色 RAL6027
产品型号	YG1470-HSED- KA04SC01-G	YG1470-HSED- KA04SC01-H	YG1470-HSED- KA04SC01-J	YG1470-HSED- KA04SC01-K	YG1470-HSED- KA04SC01-L	YG1470-HSED- KA04SC01-M	YG1470-HSED- KA04SC01-O

注：产品配色的标准为RAL标准。

【4Pair线端——直式插孔(带CPA)】

键位编码	A	B	C	D	E	F	Z
键位图示							
颜色&色标	黑色 RAL9005	白色 RAL9010	淡蓝色 RAL5012	酒红紫 RAL4004	五月绿 RAL6017	深棕色 RAL8011	水蓝色 RAL5021
产品型号	YG1470-HSED- KA04SC02-A	YG1470-HSED- KA04SC02-B	YG1470-HSED- KA04SC02-C	YG1470-HSED- KA04SC02-D	YG1470-HSED- KA04SC02-E	YG1470-HSED- KA04SC02-F	YG1470-HSED- KA04SC02-Z

键位编码	G	H	J	K	L	M	O
键位图示							
颜色&色标	铂灰色 RAL7036	淡粉色 RAL3015	米色 RAL1001	咖喱色 RAL1027	黄绿色 RAL6018	淡橘色 RAL2003	淡绿色 RAL6027
产品型号	YG1470-HSED- KA04SC02-G	YG1470-HSED- KA04SC02-H	YG1470-HSED- KA04SC02-J	YG1470-HSED- KA04SC02-K	YG1470-HSED- KA04SC02-L	YG1470-HSED- KA04SC02-M	YG1470-HSED- KA04SC02-O

注：产品配色的标准为RAL标准。

【产品型号以及键位】

【6Pair线端——直式插孔(不带CPA)】

键位编码	A	B	C	D	E	F	Z
键位图示							
颜色&色标	黑色 RAL9005	白色 RAL9010	淡蓝色 RAL5012	酒红紫 RAL4004	五月绿 RAL6017	深棕色 RAL8011	水蓝色 RAL5021
产品型号	YG1470-HSED- KA06SC01-A	YG1470-HSED- KA06SC01-B	YG1470-HSED- KA06SC01-C	YG1470-HSED- KA06SC01-D	YG1470-HSED- KA06SC01-E	YG1470-HSED- KA06SC01-F	YG1470-HSED- KA06SC01-Z

键位编码	G	H	J	K	L	M	O
键位图示							
颜色&色标	铂灰色 RAL7036	淡粉色 RAL3015	米色 RAL1001	咖喱色 RAL1027	黄绿色 RAL6018	淡橘色 RAL2003	淡绿色 RAL6027
产品型号	YG1470-HSED- KA06SC01-G	YG1470-HSED- KA06SC01-H	YG1470-HSED- KA06SC01-J	YG1470-HSED- KA06SC01-K	YG1470-HSED- KA06SC01-L	YG1470-HSED- KA06SC01-M	YG1470-HSED- KA06SC01-O

注：产品配色的标准为RAL标准。

【6Pair线端——直式插孔(带CPA)】

键位编码	A	B	C	D	E	F	Z
键位图示							
颜色&色标	黑色 RAL9005	白色 RAL9010	淡蓝色 RAL5012	酒红紫 RAL4004	五月绿 RAL6017	深棕色 RAL8011	水蓝色 RAL5021
产品型号	YG1470-HSED- KA06SC02-A	YG1470-HSED- KA06SC02-B	YG1470-HSED- KA06SC02-C	YG1470-HSED- KA06SC02-D	YG1470-HSED- KA06SC02-E	YG1470-HSED- KA06SC02-F	YG1470-HSED- KA06SC02-Z

键位编码	G	H	J	K	L	M	O
键位图示							
颜色&色标	铂灰色 RAL7036	淡粉色 RAL3015	米色 RAL1001	咖喱色 RAL1027	黄绿色 RAL6018	淡橘色 RAL2003	淡绿色 RAL6027
产品型号	YG1470-HSED- KA06SC02-G	YG1470-HSED- KA06SC02-H	YG1470-HSED- KA06SC02-J	YG1470-HSED- KA06SC02-K	YG1470-HSED- KA06SC02-L	YG1470-HSED- KA06SC02-M	YG1470-HSED- KA06SC02-O

注：产品配色的标准为RAL标准。

A series of horizontal dashed lines for writing, spanning the width of the page.



永贵科技



四川永贵科技有限公司

SICHUAN YONGGUI SCIENCE AND TECHNOLOGY CO., LTD



地址：四川省绵阳市涪城区金家林上街68号
Address: 68 Jinjialin Street, Fucheng District, Mianyang City



电话：0816-2865042
Tel: 0816-2865042



网址：<https://www.yonggui-sc.com>
Website: <https://www.yonggui-sc.com>



永贵科技公众号

永贵科技视频号