

# MEC-1001

Ultra-small Wide-temperature Fanless Industrial Embedded PC

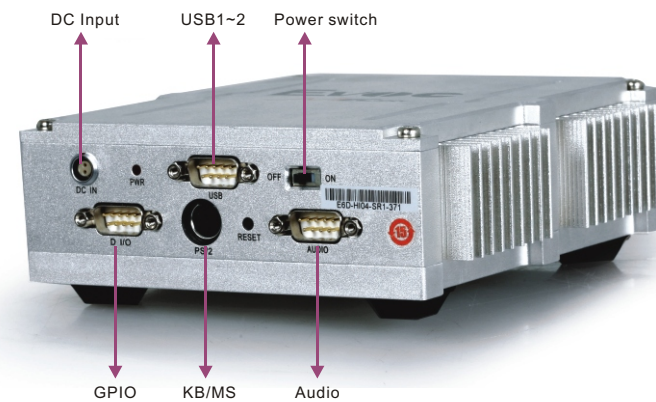
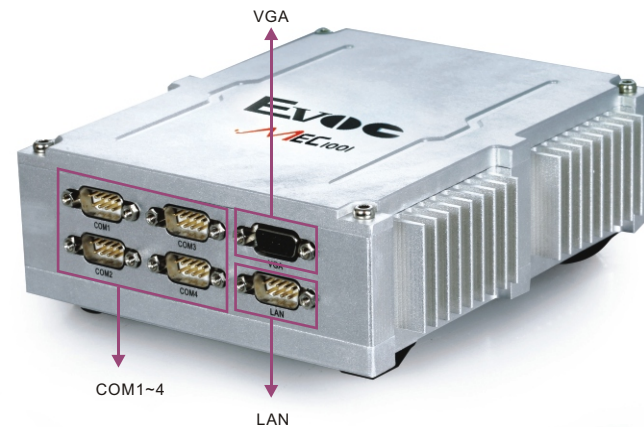

## Features

- Onboard AMD LX800 CPU
- Onboard 128MB DDR memory(256MB optional)
- Supports 1 x 10/100Mbps Ethernet interface
- Supports 4 x COM, 2 x USB2.0, 1 x CF, 1 x PS/2 port(KB/MS), 1 x Audio

## Specifications

System	
Processor	Onboard AMD LX800 500MHz CPU
Chipset	AMD Geode LX800 + AMD CS5536
Memory	Onboard 128MB DDR memory(256MB optional)
Hardware Monitor	Monitors CPU temperature, voltage, and watchdog timer
Watchdog Timer	Software programmable supports 1~255 sec./min. timer system reset or interrupt
Expansion Interface	1 x PCI-104
Storage	
IDE	1 x ultra ATA 66/100 interface
Serial ATA	N/A
Floppy	N/A
CF	1 x CompactFlash socket type I/II(optional)
DOC/DOM	N/A
I/O Interface	
USB	2 x USB2.0 port
Serial Port	3 x RS-232, 1 x RS232/422/485
Parallel Port	N/A
GPIO	4 x GPI, 4 x GPO
Audio	Supports AC'97, available interfaces of Speaker-out and Mic-in
Display	
Chipset	AMD chipset intergraded graphics acceleration controller
Memory	8MB shared memory
Resolution	VGA mode up to 1600 x 1200@85Hz
Dual Display	N/A

Ethernet	
Chipset	Intel® EP 82562ET
Speed	10/100Mbps
Connector	1 x RJ45
Mechanical and Environmental	
Dimensions	152mm(W) x 49mm(H) x 166mm(D)
Reliability	MTBF ≥ 30000h; MTTR ≤ 0.5h
Operating Temperature	-10 C~65 C, -40 C~85 C(optional)
Storage Temperature	-40 C~85 C
Operating Humidity	20%-93%, 40 C non-condensing
Power	
Power Supply	Single 5V input
Power Consumption	Typical 9.8W (AMD LX800 500Mhz, 256MB memory)
Operating System	
Windows OS	Windows 98SE/ Windows 2000/ Windows XP
Embedded OS	Linux/XP Embedded/Window CE
Test	
Vibration	5-15Hz/0.4mm amplitude, 15-200Hz/1.5g acceleration
Shock	20g peak acceleration(11ms duration)
EMC/EMI	GB 9254-1998 Class A, GB/T17625.1-1998 Class D

## Dimensions

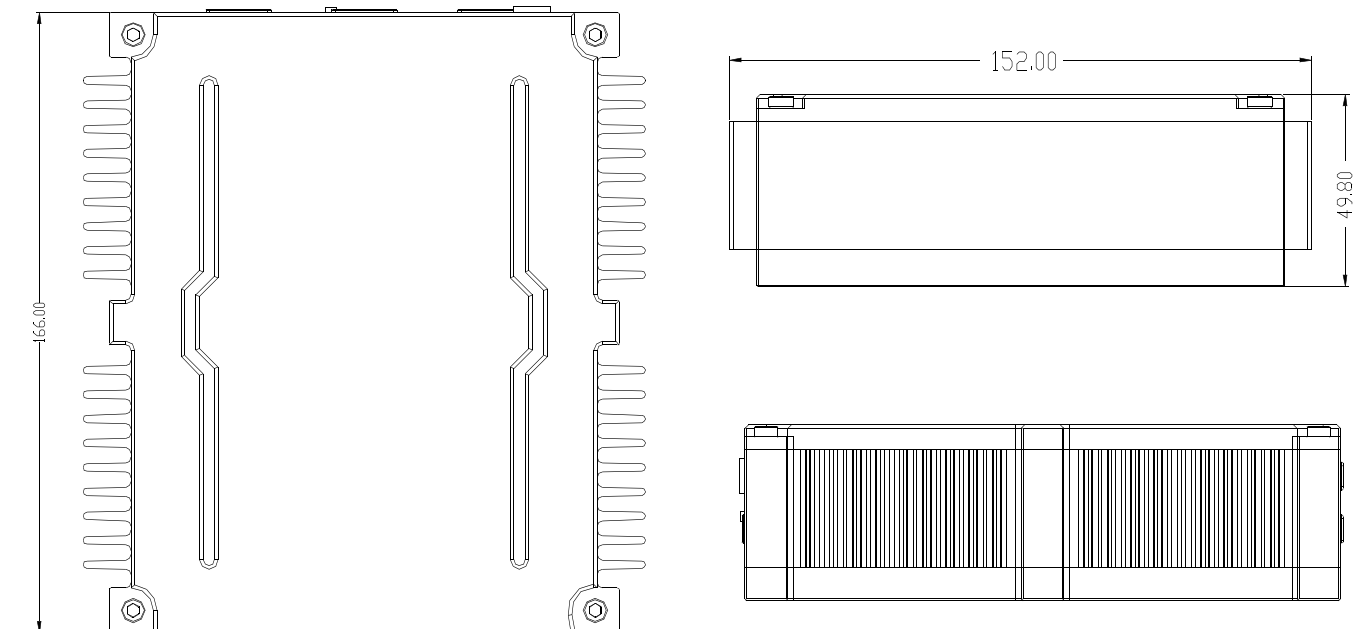

## Available Accessories

Part Number	Name	Description	Qty.
2360-019661	AV cable/RoHS	DB9 connector to 3.5mm audio port/UL=2547/26AWG/length: 100mm	1
2360-019671	LAN cable/RoHS	DB9 connector to RJ45 connector/24AWG/L=100mm	1
2360-019711	USB cable/RoHS	DB9 connector to Dual USB ports/UL=2725/28AWG/length: 100mm	1
2360-005031	Y-cable for keyboard and mouse/RoHS	One minDIN port to two PS/2 ports, length: 250mm/RoHS	1
2331-008081	Sheath for aviation socket/RoHS	700022208960040 L=27mm	1
2331-008091	Aviation socket/RoHS	S20LOC-P02MJG0-5200 2PIN/10A	1
2100-055840	Power adapter (optional)	20W/ADP-H40S5II	1
2360-003671	AC power cable (optional)	USA standard 821, length: 1500mm	1
	Driver CD/Protective film/RoHS	MEC-1001 Long March No.1	1
	User's Manual/RoHS	MEC-1001 series/Long March series	1

## Ordering Information

Part Number	Model Number	Description
0010-000480	MEC-1001-01	Complete PC: LX-800/128M/2G CF card/104-1642CLDNA/ MEC-1001-IO1& IO2/104-PES01
0010-016160	MEC-1001-02	Complete PC: LX-800/128M/40G HDD/104-1642CLDNA/ MEC-1001-IO1& IO2/104-PES01
0010-016270	MEC-1001-03	Complete PC: Low power LX-800/128M/2G CF card/104-1642CLDNA/ MEC-1001-IO1/MEC-1001-IO2/20W power supply ADP-H40S5II/
0010-016280	MEC-1001-04	Complete PC: LX-800/128M/40G HDD/104-1642CLDNA/ MEC-1001-IO1&IO2/104-PES01/20W power supply ADP-H40S5II
0020-000430	MEC-1001-01/no power supply/no backplane	Empty chassis
0020-036000	MEC-1001-02/no power supply/no backplane	Empty chassis
0020-036170	MEC-1001-03/no power supply/no backplane	Empty chassis
0020-036180	MEC-1001-04/no power supply/no backplane	Empty chassis